

CDBHM120L-HF Thru. CDBHM1100L-HF

Reverse Voltage: 20 to 100 Volts

Forward Current: 1.0 Amp

RoHS Device
Halogen Free

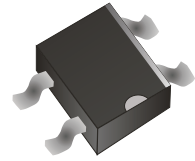

Features

- Ideal for printed circuit board
- High current capability, Low Forward voltage drop meets profile.
- Lead-free part meets RoHS requirements.

Mechanical data

- Case: molded plastic
- Epoxy: UL 94V-0 rate flame retardant.
- Lead: solder plated
- Polarity: As marked
- Weight: 0.125 gram(approx)

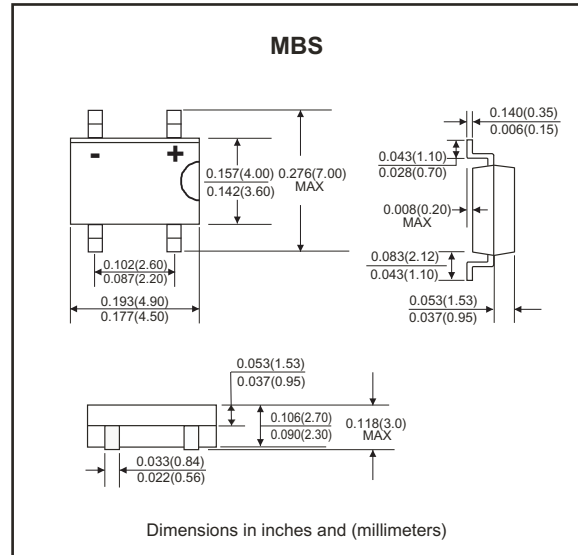

Maximum Ratings and Electrical Characteristics

Rating at 25°C ambient temperature unless otherwise specified.
Single phase, half wave, 60Hz resistive or inductive load.
For capacitive load, derate current by 20%

Parameter	Symbol	CDBHM 120L-HF	CDBHM 140L-HF	CDBHM 160L-HF	CDBHM 180L-HF	CDBHM 1100L-HF	Units
Maximum. Repetitive peak reverse voltage	V_{RRM}	20	40	60	80	100	V
Maximum. DC blocking voltage	V_{DC}	20	40	60	80	100	V
Maximum. RMS voltage	V_{RMS}	14	28	42	56	70	V
Maximum. Instantaneous forward voltage @ 0.5A	V_F	0.55		0.65	0.85		V
Average Forward rectified current 0.2*0.2" (5.0*5.0mm)copper pad area ,(see figure 1)	I_{AV}	1.0					A
Peak Forward surge current,8.3ms single half sine-wave superimposed on Rated Load (JEDEC method)	I_{FSM}	40					A
Maximum. DC reverse current @TA=25°C rated DC blocking voltage per leg @TA=100°C	I_R	0.5 20					mA
Typical thermal resistance(Note 3)	$R_{\theta JA}$	85					°C/W
	$R_{\theta JL}$	20					
Typical junction capacitance(Note 2)	C_J	250			125		pF
Operating temperature range	T_J	-55 to +125			-55 to +150		°C
Storage temperature range	T_{STG}	-55 to +150					°C

- Notes: 1.Pulse test: 300µS pulse width, 1% duty cycle.
2.Measured at 1.0MHz and applied reverse voltage of 4.0 Voltage.
3.Thermal resistance from junction to ambient and from junction to lead P.C.B. mounted on 0.2x0.2" (5.0x5.0mm) copper pad areas.

Company reserves the right to improve product design , functions and reliability without notice.

REV: C

RATING AND CHARACTERISTIC CURVES (CDBHM120L-HF Thru. CDBHM1100L-HF)

Fig.1 - Maximum Forward Current Derating Curve

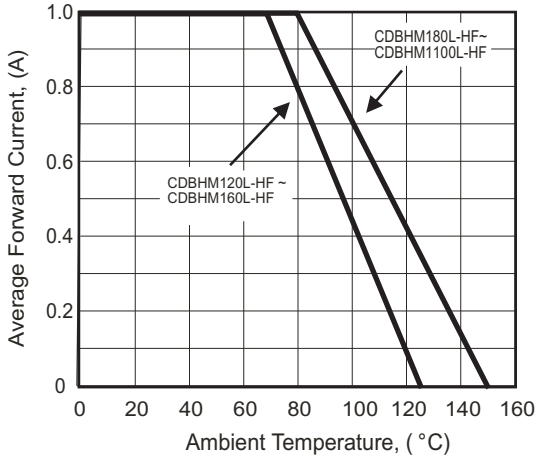

Fig. 2 - Typical Instantaneous Forward Characteristics Per Bridge Element

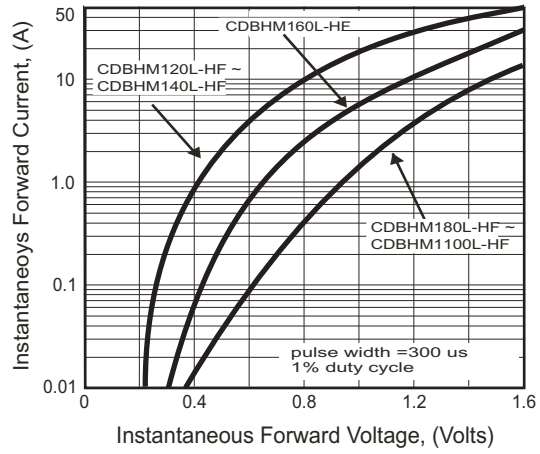

Fig. 3 - Maximum Non-Repetitive Forward Surge Current Per Bridge Element

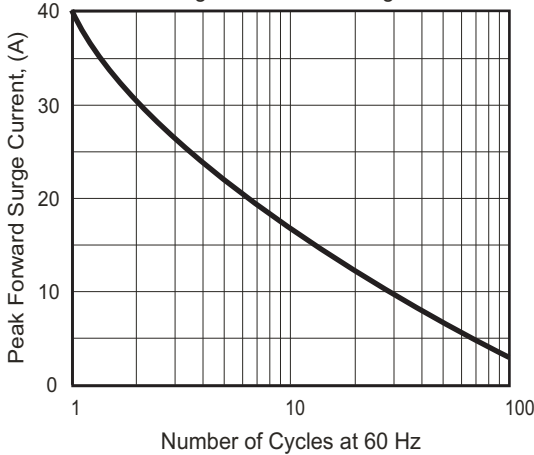
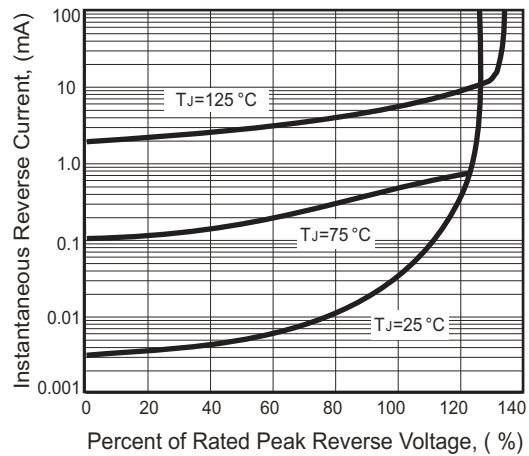
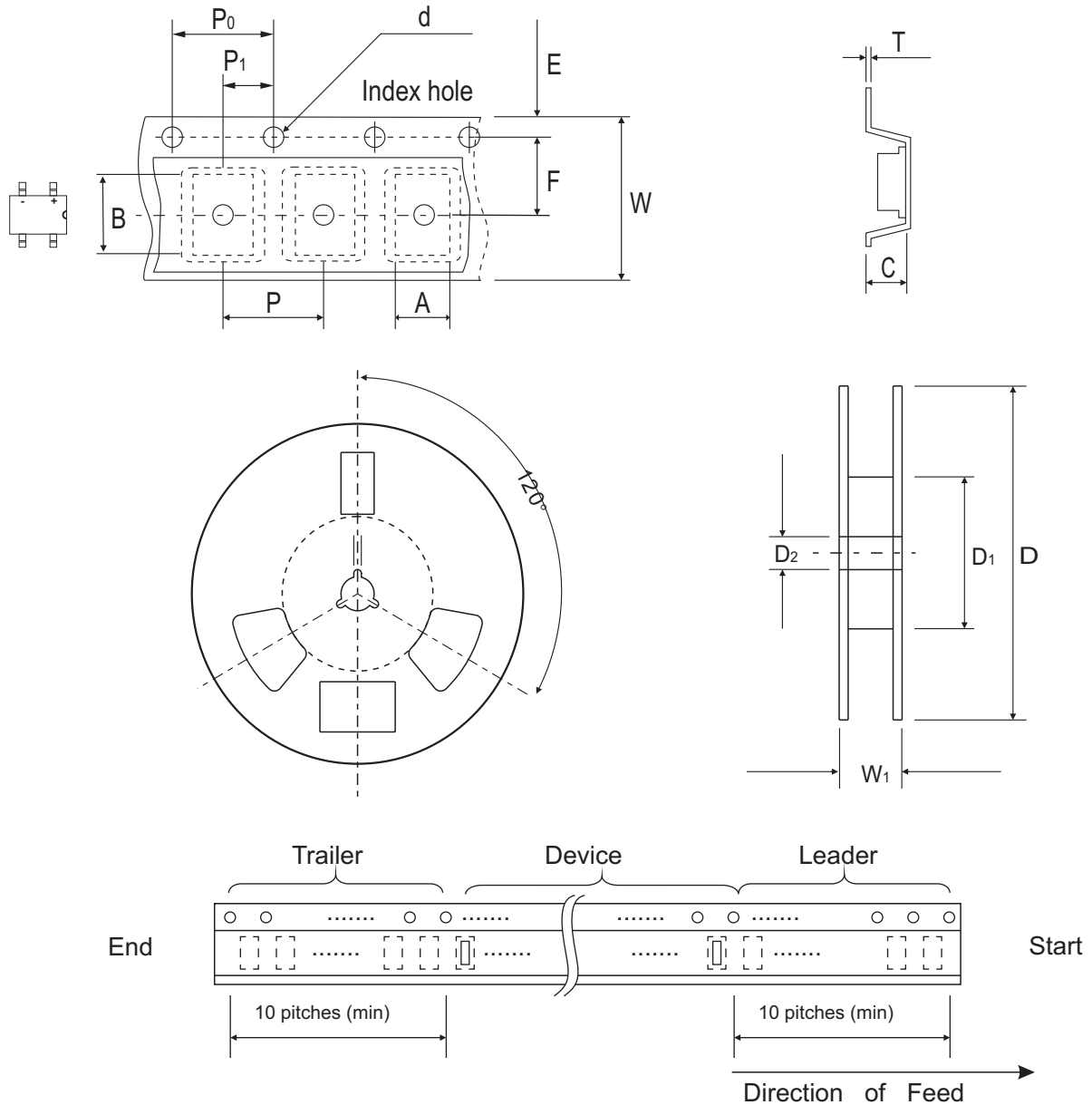

Fig. 4 - Typical Reverse Characteristics Per Bridge Element



Reel Taping Specification



MBS	SYMBOL	A	B	C	d	D	D1	D2
	(mm)	5.00 ± 0.01	7.24 ± 0.10	2.95 ± 0.10	1.50 ± 0.10	330.0	50.0 MIN.	13.0 ± 0.20
	(inch)	0.197 ± 0.004	0.285 ± 0.004	0.116 ± 0.004	0.059 ± 0.004	13.00	1.969 MIN.	0.512 ± 0.008

MBS	SYMBOL	E	F	P	P0	P1	W	W1
	(mm)	1.75 ± 0.10	5.50 ± 0.05	8.00 ± 0.10	4.00 ± 0.10	2.00 ± 0.05	12.00 ± 0.30	12.0~14.40
	(inch)	0.069 ± 0.004	0.217 ± 0.002	0.315 ± 0.004	0.157 ± 0.004	0.079 ± 0.002	0.472 ± 0.012	0.472~0.657

Marking Code

Part Number	Marking Code
CDBHM120L-HF	MBSK12SE
CDBHM140L-HF	MBSK14SE
CDBHM160L-HF	MBSK16SE
CDBHM180L-HF	MBSK18SE
CDBHM1100L-HF	MBSK110SE

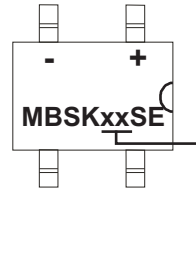

xx/xxx = Product type marking code

Suggested PAD Layout

SIZE	MBS	
	(mm)	(inch)
A	2.40	0.094
B	0.90	0.035
C	1.84	0.072
D	6.00	0.236

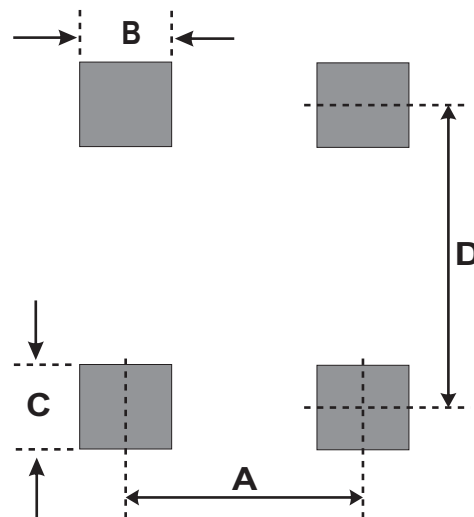

Standard Packaging

Case Type	Qty Per Reel	Reel Size
	(Pcs)	(inch)
MBS	2,500	13